

# THE NEW LUB PROJECT



# 2020



























# SEGMENT AGRI

# WAAROM DEZE NIEUWE TOTAL VERPAKKINGSLIJN

## Inleiding – Het product verdient een verpakking die de inhoud weerspiegelt

Motoroliën zijn technische producten die beantwoorden aan de specifieke behoeften die worden beschreven door:

 ACEA								ILSAC Approved	
									
									

VISCOSITY GRADE

API NORM

ACEA NORM

OEM REQUIREMENTS



# NIEUWE FOCUS

## Optimaliseren van kleinverpakkingen



**Krachtig design**



**Bescherming tegen imitaties / namaak**



**Labels Total merk imago**



**Logistieke aanpassingen**



**Duurzaamheid**



**Verbeterde leesbaarheid, productspecificaties en OEM goedkeuringen**

# DE UITKOMST

Het Total kleinverpakkingen assortiment is gecategoriseerd in 3 verschillende technologieën (niveaus):



# KLEURENSTRATEGIE VERPAKKING

Gebaseerd op  
marktontwikkelingen  
en behoeften



Herkenning assortiment;  
Segmentatie en hiërarchie  
in productkwaliteit



Kleurenstrategie biedt  
informatie structuur



Kleurenstrategie helpt bij  
positioneren product



# DESIGN

## In details

Verbeterde sluitingen (caps)



Groot handvat



Grotere labels



Nieuw label

Huidig label

# EEN AANTAL NIEUWE LOGO'S

Van oud naar nieuw





# LABEL INDELING

## Voorzijde

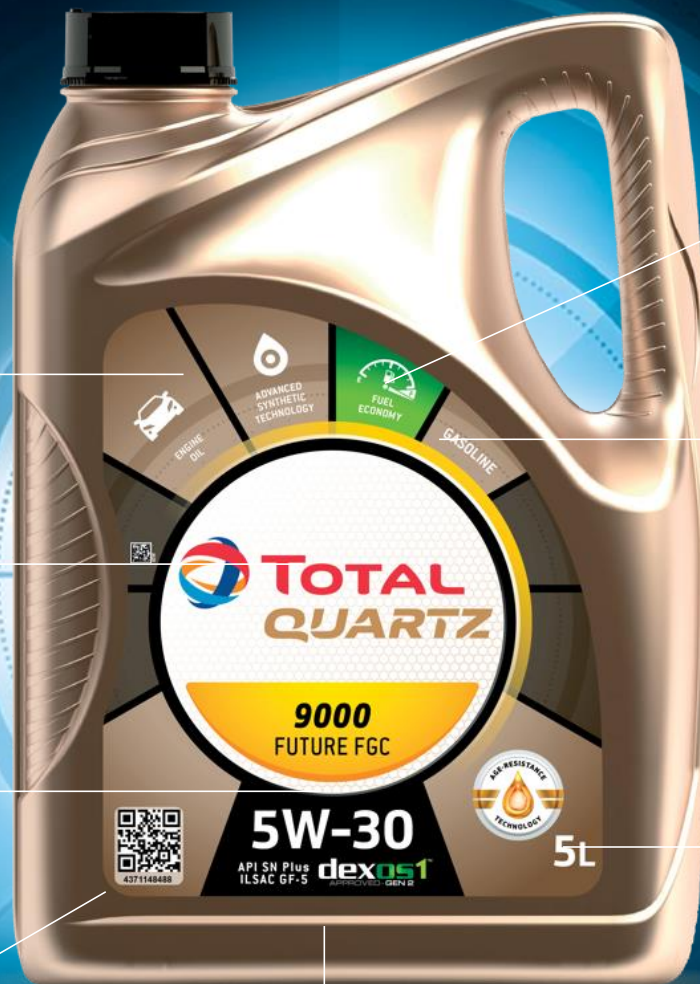

### Pictogrammen

Toepassing, type basisolie, etc.



### Assortiment logo



### Product naam



### QR Code

Bepalen echtheid van product



### Viscositeit en/of OEM goedkeuringen

### Product eigenschappen



### Diesel / benzine



### Technische specificaties en product voordelen



# LABEL INDELING

## Voorbeeld achterzijde



Merk



OEM goedkeuringen en internationale specificaties



Total HQ informatie, generieke code, informatie



Type cap



Meertalige informatie & HSEQ informatie

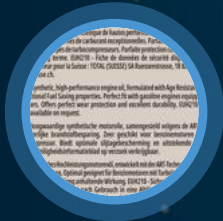

# DOPPEN

## Meerdere types

RING PEEL LINER



Verbeterde,  
beveiligde afdichting

FLEXSPOUT



Verbeterd,  
gelijkmatig uitgieten

IHS STANDARD



Folie afsluiting,  
vermijden van lekkages

DOSING



Gieter met nauwkeurige  
dosering (bv. 2 takt)



# DESIGN

## Nieuwe kleinverpakking



HUIDIG  
DESIGN



NIEUW  
DESIGN

# INTRODUCTIE

Nieuwe kleinverpakkingen assortiment

NIEUW  
DESIGN





# INTRODUCTIE

## Nieuwe Total Agri kleinverpakkingen

NIEUW  
DESIGN





# VERPAKKING

Upgrade uitstraling



 **TOTAL  
QUARTZ**

 **TOTAL  
HI-PERF**

 **TOTAL  
RUBIA**



OVERIGE  
TOTAL  
ASSORTIMENT



OVERIGE  
VERPAKKINGEN

(KOELVLOEISTOFFEN)

# VERPAKKING

## Upgrade uitstraling

Liters	Verpakkingen	Dozen	Doos gewicht (KG)	Doos capaciteit	Ppal C and X	Ppal Z
0,25L	72X45X132	379X228X152	5.82	24 x 0.25L	7 levels of 15 cartons	7 levels of 10 cartons
0,5L	91.4X52.5X170	378X226X190	7.60	16 x 0.5L	5 levels of 15 cartons	6 levels of 10 cartons
1L	108X60X230	379X228X250	11.04	12 x 1L	3 levels of 15 cartons	5 levels of 10 cartons
5L	216X120X300	379X228X320	13.38	3 x 5L	3 levels of 15 cartons	4 levels of 10 cartons

# LOGISTIEK

## Dozen en pallets

24 x 0.25L FLACONS

16 x 0.5L FLACONS

12 x 1L FLESSEN

3 x 5L CANS

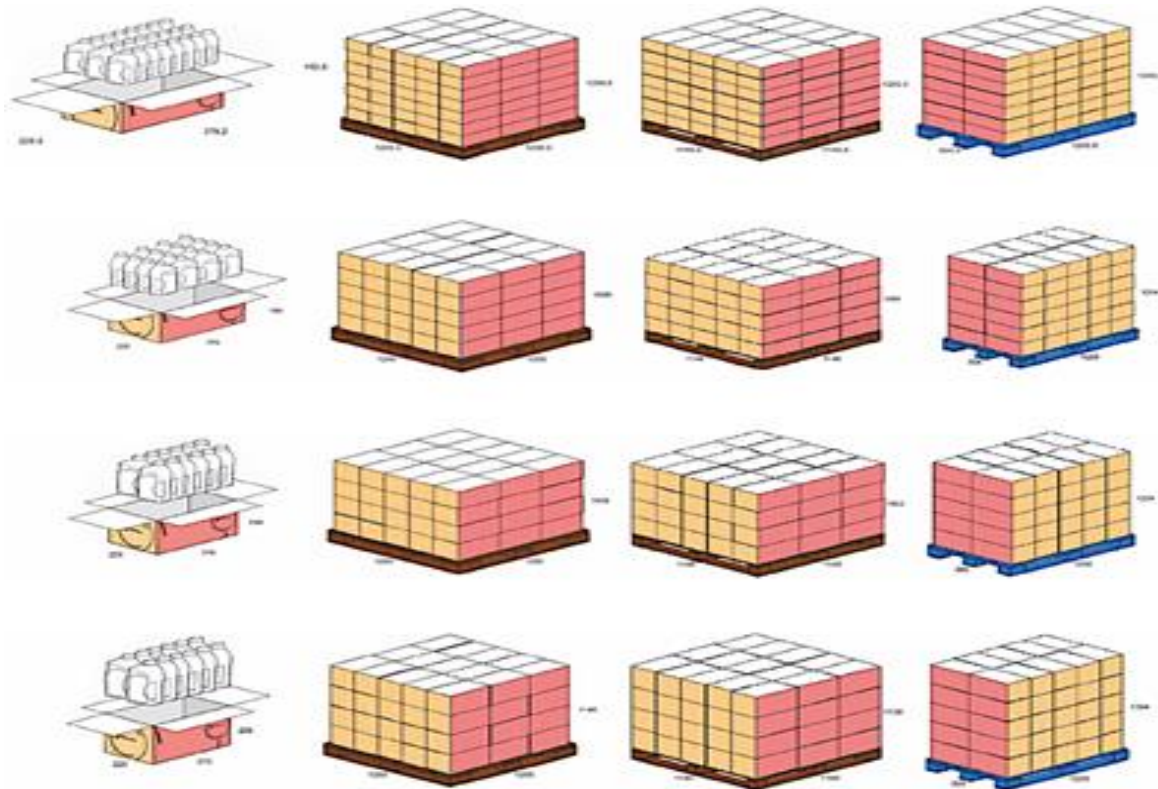



# ORDERS & INTRODUCTIE

**START  
PRODUCTIE  
& LEVERING**



**EIND JANUARI,  
BEGIN FEBRUARI  
2020**

**DOORLOOPTIJD  
NIEUWE  
VERPAKKINGEN**



**0 – 6 MAANDEN  
(DOORLOPEND)**

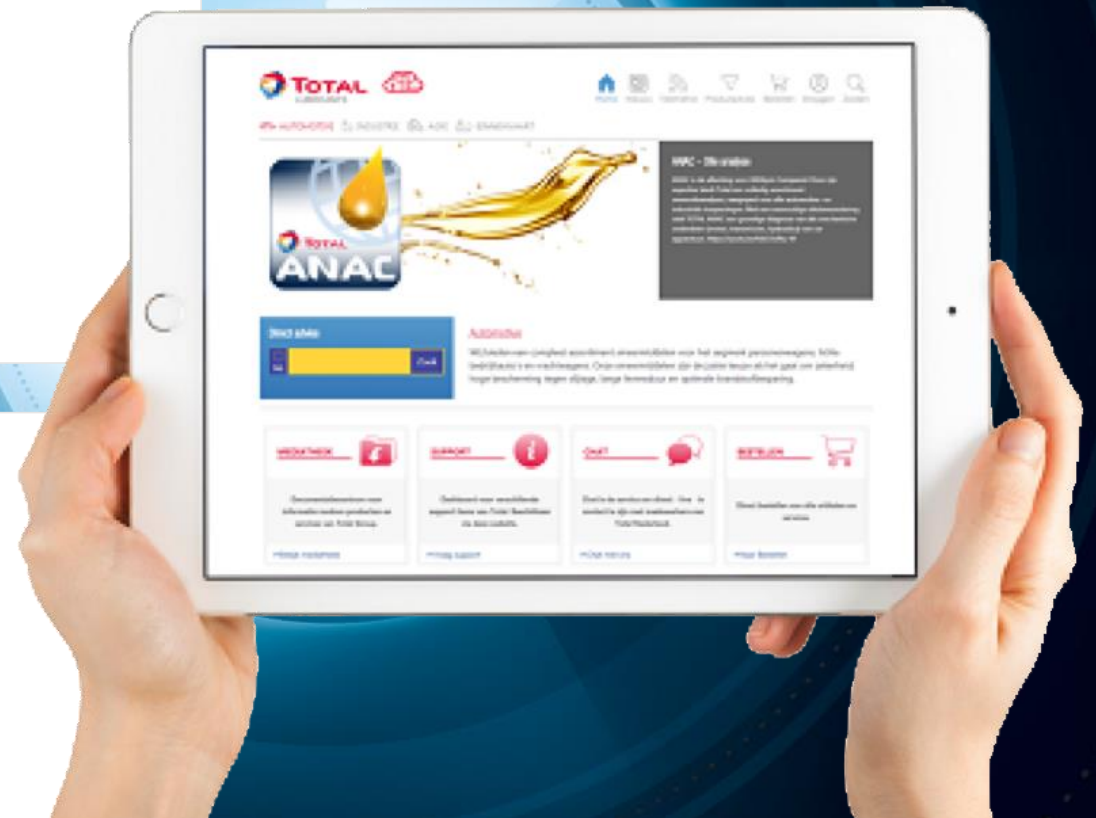



# TOTAL AGRI ASSORTIMENT



# TOTAL AGRI ASSORTIMENT

Assortiment agricultuur blijft onveranderd, met de navolgende structuur.

TOEPASSING	ASSORTIMENT	SPECIFICATIES
Motor oliën	Tractagri	ACEA Ex   API Cx-4
Utto (Transmissie)	Dynatrans	API GL-4
Assen (Transmissie)	Dynatrans	API GL-5
STOU (Super Tractor Oil Universal)	Multagri	ACEA Ex   API Cx-4   API GL-4
Hydraulische oliën	Hydragri Biohydran etc.	ISO VG XX
Smeervet	A-Grease	NLGI 2
Kettingzaag oliën	Prosylva Chain	ISO VG XX
Tuinbouw	Prosylva	ACEA Ax – Bx/API Sx
Koelvloeistof	Coolagri Organic -37°C	Organische Technologie





# TOTAL AGRI PRODUCTS PER RANGE

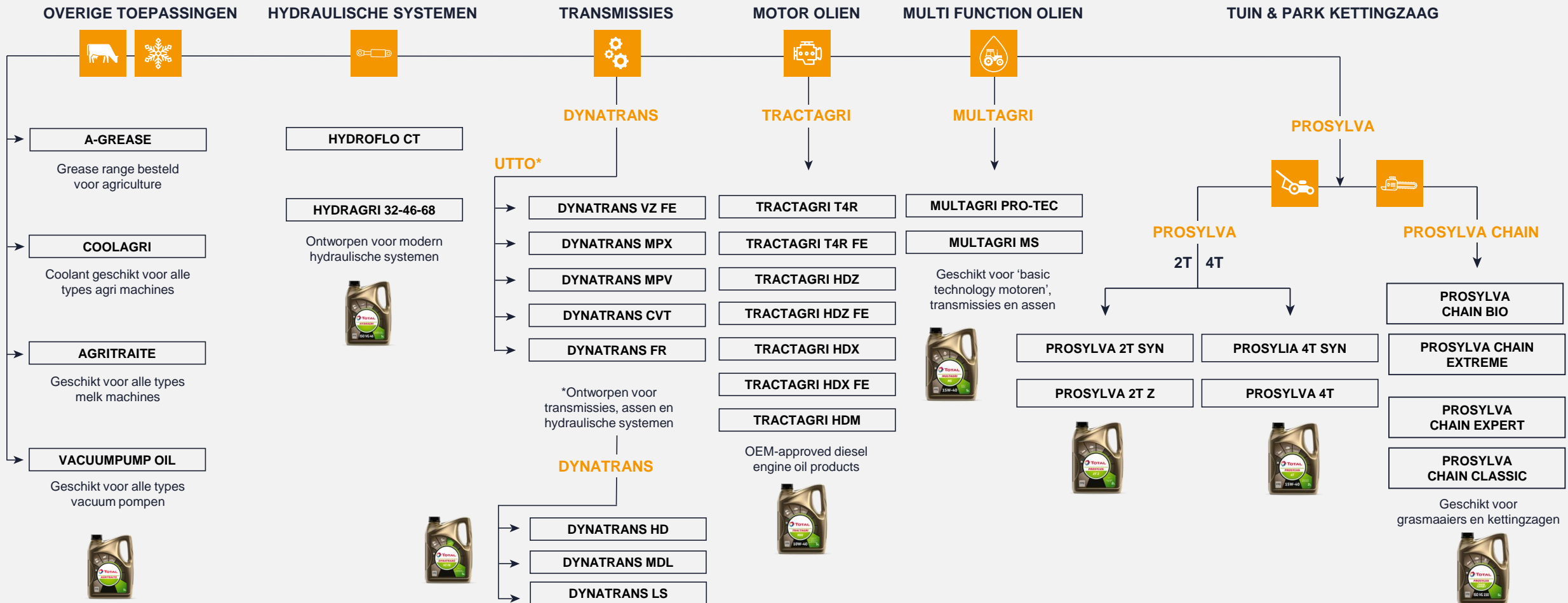

\*Universele Tractor Transmissie Olie



# GRONDVERZET ASSORTIMENT

# TOTAL GRONDVERZET ASSORTIMENT



## TRANSMISSIES



- DYNATRANS ACX
- DYNATRANS AC\*
- DYNATRANS DA

## HYDRAULISCHE SYSTEMEN



- EQUIVIS HE
- HYDROFLO CT
- EQUIVIS ZS

ONTWORPEN VOOR  
HYDRAULISCHE  
SYSTEMEN

### TOTAL STAR CONCEPT

- STAR MAX FE 10W-30  
STAR TRANS 80W-110
- STAR TRANS FE 75W-90

RATIONALISATIE  
VOOR  
HYDRAULIEK,  
TRANSMISSIES EN  
MOTOREN



## MOTOR OLIEN



### RUBIA WORKS

- RUBIA WORKS 4000
- RUBIA WORKS 3000
- RUBIA WORKS 2X00\*
- RUBIA WORKS 1000

OEM- GOEDGEKEURD  
(MIJN)BOUW-  
PRODUCTEN

### RUBIA MONO

- RUBIA G 1700
- RUBIA SX
- RUBIA G1300
- RUBIA S\*

\*Producten die niet meer leverbaar zijn



# TOTAL RUBIA WORKS EN TOTAL STAR CONCEPT ASSORTIMENT

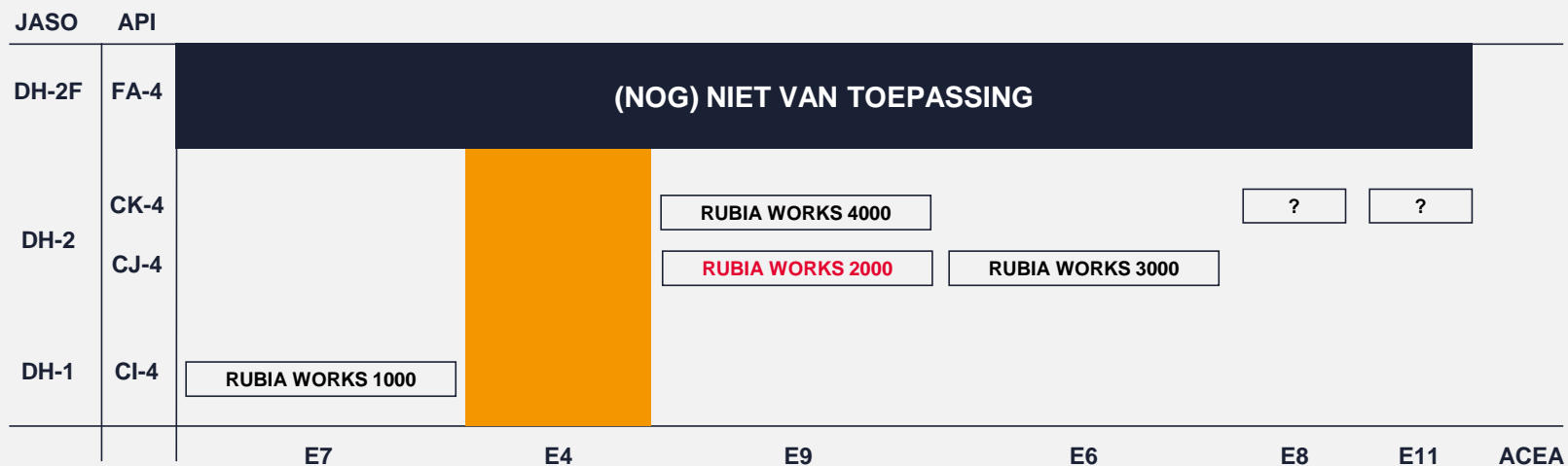

Alle TOTAL RUBIA WORKS en STAR MAX FE goedgekeurd door OFF-ROAD en ON-ROAD OEMs + JASO-specificatie.

TOTAL STAR CONCEPT

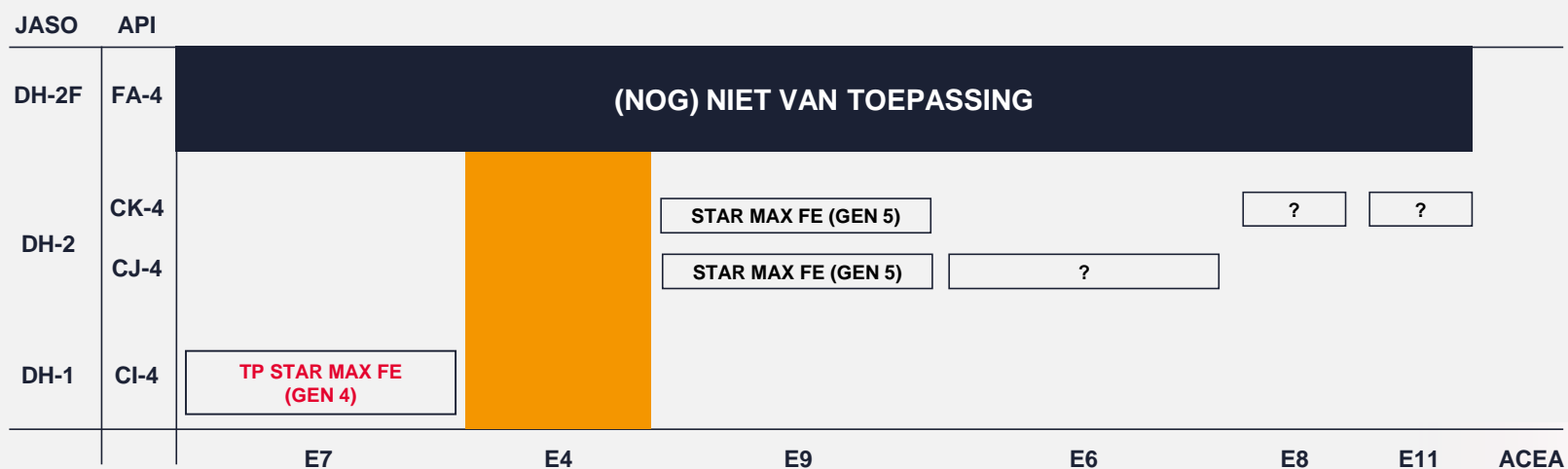

PRODUCTEN WORDEN GESLOTEN



# TRANSMISSIE OLIEN ASSORTIMENT

# TRANSMISSIE OLIE

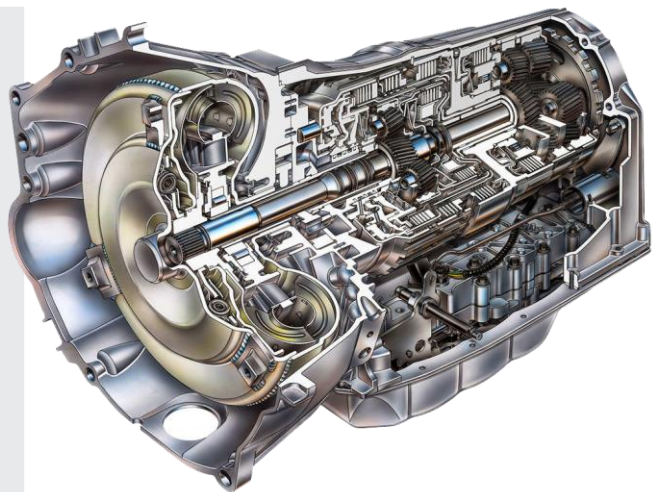

**AUTOMATISCHE  
TRANSMISSIE**

**ATF**

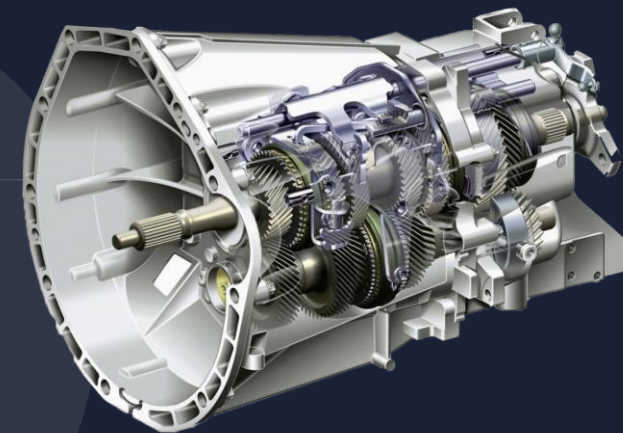

**HANDGESCHAKELDE  
TRANSMISSIE  
EN ASSEN**  
**MTF**





# AUTOMATISCHE TRANSMISSIE OLIEN

Heavy Duty



## OEM-GOEDGEKEURDE PRODUCTEN, HD-GEORIENTEERD

### FLUIDMATIC

FLUID PROFIEL		HUDIGE BENAMING	NIEUWE ROOT NAAM	NIEUWE SUFFIX
GM TASA	OEM-goedgekeurd	FLUIDE CC	ELFMATIC G3	
DEXRON IID	OEM-goedgekeurd	FLUIDE ATX		
DEXRON IIIH/ MERCON	OEM-goedgekeurd	FLUIDE G3		
DEXRON IIIH/ MERCON V	OEM-goedgekeurd	FLUIDE XLD FE	FLUIDMATIC	XLD FE
ALLISON TES-295	OEM-goedgekeurd			SYN T295

# AUTOMATISCHE TRANSMISSIE OLIEN

Personenauto /  
Bestelwagens



PC/LCV-GEORIENTEERD				
FLUIDMATIC				
AUTOMATIC TRANSMISSIE TYPE	PROFIEL	HUIDIGE BENAMING	NIEUWE ROOT NAAM	NIEUWE SUFFIX
AT: DEXRON VI MERCON LV	PERFORMANCE LEVEL	FLUIDMATIC MV LV	FLUIDMATIC	LV MV
CVT	PERFORMANCE LEVEL	FLUIDMATIC CVT MV		CVT MV
DCT	PERFORMANCE LEVEL	FLUIDMATIC DCT MV		DCT MV

**LCV** Light Commercial Vehicle

**DCT** Dual-Clutch Transmission

**CVT** Continuous Variable Transmission

**AT** Automatic Transmission

**PC** Passenger Car

# AUTOMATISCHE TRANSMISSIE OLIEN

Personenauto /  
Bestelwagens



## ATF VOOR EEN SPECIFIEKE OEM/TOEPASSING

### FLUIDMATIC

PROFIEL		HUIDIGE BENAMING	NIEUWE ROOT NAAM	NIEUWE SUFFIX
FORD TYPE F	PERFORMANCE LEVEL	ATF 33	FLUIDMATIC	F TYPE
MB 7 SPEEDS	OEM-approved	FLUIDMATIC 7S		7S
DEXRON IID	OEM-approved	FLUIDE ATX		ELFMATIC G3
DEXRON IIIG	OEM-approved	FLUIDE AT 42		AT 42

ATF: Automatic Transmission Fluid



# HANDGESCHAKELDE TRANSMISSIE & ASSEN

NAAM	TOEPASSING	HIERARCHIE	FE	GRADE
Traxium*	Gear	9	FE Of Geen FE	75W-90 (bijvoorbeeld)
	Dual	8		
	Axle	6		

## OLIEN MET OEM GOEDKEURINGEN

### Toepassing

Gear (gear oil)  
Axle (axle oil)  
Dual (gear + axle oil)

### Tier

9 (High level)  
8 (Mid level)  
7 (Low level)  
6 (Instap level: "geschikt voor")

## HIERARCHIE CRITERIA

Aantal OEM goedkeuringen  
FE (8 of 9)  
Olie verversingstermijn

*\*Trans wordt Traxium. Alles blijft verder ongewijzigd.*